

Ground Fault Cable Retractor GR900 Series Service Manual

AERO-MOTIVE COMPANY



A Woodhead Industries, Inc. Subsidiary

IMPORTANT SAFETY INSTRUCTIONS

Please read this manual carefully and follow its instructions. Improper use or failure to follow these instructions could result in serious injury, death or property damage. Operators should be instructed in the safe and proper use and maintenance of this product. Keep this manual for future reference.

The following safety precautions call attention to potentially dangerous conditions.



DANGER: Immediate hazards which **WILL** result in severe personal injury or death.



WARNING: Hazards or unsafe practices which **COULD** result in severe personal injury or death.



CAUTION: Hazards or unsafe practices which **MAY** result in *minor* personal injury or product or property damage.

Model GR900 retracts up to 40 feet of #1/0 or #2/0 AWG grounding cable intended to protect equipment and personnel in the event of a ground fault. The collector rings' electrical path through the reel has a current carrying capacity greater than that of the largest cable (#2/0 AWG) to be installed on the reel.



WARNING: Failure to lock the cable drum in position with the cable fully extended as instructed, will create an explosion hazard in the even of fault condition, and may result in property damage, personal injury, or death.



WARNING: The internal electrical path is not insulated from the reel frame, therefore, this reel is unsuitable for other uses other than retracting ground cables. Use for other applications will create an electrical shock hazard, and could result in property damage, personal injury, or death.



WARNING: Failure to install, operate, and maintain the retractor in accordance with these instructions may result in electrical shock causing property damage, personal injury, or death.



WARNING: If ground fault has occurred, return the reel to Aero-Motive Company for inspection , and possible repair before placing back in service. Failure to do so could result in electrical shock hazard, and may result in property damage, personal injury, or death.

Installation



CAUTION: Misalignment of the reel and cable travel direction will cause the cable to be deflected at a sharp angle around the cable guide rollers



CAUTION: The reel should be bolted securely to a flat metal surface of sufficient strength and rigidity to support it under all conditions to which it will be subjected. Mounting holes will accommodate 7/16" or 3/8" bolts. Nothing smaller than 3/8" or 10mm bolts should be used.

MOUNTING

The fixed base of the reel allows mounting in several different positions including base up, base down, or wall mounted. Here are general mounting requirements:

- Main-shaft must be horizontal.
- Centerline of the spool assembly must be on line with the cable run.
- When mounted overhead in base up position, add a secondary chain, bracket or other safety device to prevent reel from falling in case the mounting bolts are removed or loosened from vibration.

INSTALLING CABLE

1. Select the proper cable size (#1/0 or #2/0 AWG) to fit the application. The cable should have fine stranding for flexibility and a jacket suitable for rough handling.
2. After removing the outer drum half (29) pass the end of the cable through the neoprene cable seal (30).
3. Adjust the neoprene cable seal (30) to fit the cable diameter by cutting away the smaller rings with a sharp knife. The remaining hole size should be smaller than the cable diameter and must stretch when inserting the cable.
4. Finish the end of the cable by either stripping and thinning or applying a suitable pin connector.
5. Insert the cable end or pin connector through the diameter hole provided in the terminal on the rotating portion of the slip ring assembly (27).
6. Lock the cable securely in place with the set screw and jam nut provided.
7. Clamp the cable to the inside of the inner drum half (33) using the two hole clamp (23), screws (25), and washers (24). Provide slack between the cable termination on the slip ring assembly (27), and the cable clamp (23) to allow free alignment.
8. Reinstall the outer drum half (29) and drum gasket (26) with the four screws.

WARNING: All steps related to termination of the cable must be followed carefully. Failure to properly terminate the cable may result in property damage, personal injury, or death.

9. The cable can now be wound onto the cable drum.
10. A warning label (35) is provided with the retractor and must be attached to the free end of the cable between the adjustable cable stop (34) and the point where the cable jacket is stripped off (see parts drawing). To attach the label, remove the adhesive cover from the back and place the center of the label on the center of the cable. Wrap the cable both ways from the center so both sides (if any remains) adhere to each other, back to back. (See illustration)

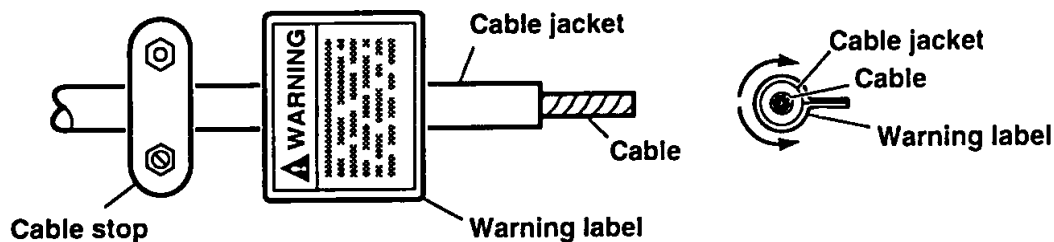

If cable is replaced at a later date contact Aero-Motive Co. 1-800-999-8559 for replacement label.

SPRING TENSIONING

 **CAUTION:** Failure to test for adequate spring revolutions can cause spring damage. Hazards or unsafe practices **MAY** result in *minor* personal injury or product or property damage.

NOTE: A minimum 2 pre-tension turns is required. Additional turns can added as long as one unused spring turn remains when cable is completely extended. If entire cable cannot be pulled out, decrease spring tension until full one turn remains.

All reels require pretensioning turns to spool assembly before connecting free end of working cable. Set spring tension by turning fully wrapped reel through a specific number of revolutions or turns. Number of pretension turns depends on application and desired tension. **A minimum of 2 set up turns is needed for most applications.** Additional tension may be added by repeating above process. Failure to pretension reel may result in insufficient tension to retract and may shorten spring life.

After cable is installed, apply the extra warning label (35) shipped with the reel, to the insulated cable that protrudes beyond the cable stop.

 **CAUTION:** Check to make sure that the cable can still be pulled out without winding the main spring to the end. If the cable can not be pulled out completely, too many prime turns have been applied and some will have to be removed. Operating the reel with too many prime turns will restrict the cable travel and shorten the life of the main spring.

CONNECTING GROUND

The ground connection cable should be as large or larger than the cable installed on the drum. It is attached to the reel by connecting to the 1/2" diameter copper rod protruding beyond the junction box cover

(11), on the base (3). Connection should be made with a commercial fitting specifically intended for attaching this size cable to 1/2" diameter copper rod.

 **WARNING:** Failure to make mechanically and electrically sound connection at both ends of the cable will create an electrical shock hazard and could result in property damage, personal injury, or death.

ADJUSTING CABLE GUIDE

Cable guide position is set by rotating the spring pocket assembly. Loosen three clamps holding spring pocket assembly in place by unscrewing three hex head bolts. Unless required, do not completely remove bolts or clamps. Reposition guide as required, making sure clamps straddle ribs on outside diameter of spring pocket assembly and retighten hex head bolts.

 **CAUTION:** Pulling the cable at sharp angles to the cable guide will shorten the cable life and retard retraction speed.

OPERATION

RATCHET LOCK

All reels are supplied with a ratchet lock to hold drum at any of several positions per drum revolution and prevent it from retracting. If ratchet lock is not required--constant tension--, move spring clip and spring to adjacent cable guide screw. To release ratchet, pull cable out until ratchet pawl disengages.

GROUND FAULT CONNECTION

When the cable is pulled out and connected to provide ground fault protection, all of the cable should be fully extended to provide maximum current capacity and a padlock must be installed on the reel through the hole provided in the flange of the spool. This padlock prevents drum rotation and assures that the cable remains unwound should a ground fault occur.

 **WARNING:** Failure to unwind the full length of cable and then padlock the spool to prevent its inadvertent rewinding, in the event of a ground fault, will create an explosion hazard which could result in property damage, personal injury, or death

 **WARNING:** Personnel should be kept at a safe distance from the Ground Fault Reel and Cable. In the event of a ground fault, the sudden surge of power will cause the cable to move violently and could cause property damage, personal injury, or death.

 **WARNING:** This reel is intended for use in a grounding circuit only. The electrical path is not insulated from the reel frame. Property damage, personal injury, or death could result if retractor is not used in accordance with this manual.

 **WARNING:** Check all electrical connections on retractor and ground cable terminations before use. Failure to do so may result in shock hazard causing property damage, personal injury, or death.

SERVICE

 **WARNING:** If ground fault condition has occurred, remove the reel from service immediately and return it to Aero-Motive Company for inspection and, if necessary, repair. Failure to do so could result in and electric shock hazard causing damage, personal injury, or death.

MAINSRING REPLACEMENT

If the reel will not develop tension or retract cable, the spring assembly may need to be replaced.

To replace the mainspring:

1. Disconnect the input grounding connection.
2. Remove junction box cover (11) and connector (12).
3. Remove shaft retainer screw (1) and shaft retainer (2).
4. Remove drum and main shaft from base (3).
5. Remove cable guide (16), spring clip (20), both screws (19), extension spring (15), shoulder screw (21), and ratchet pawl (22) from spring pocket assembly (14).
6. Remove spring pocket assembly (14) from base (3) and replace with new spring pocket assembly.

Assemble in reverse order.

 **WARNING:** Spring pocket assemblies are sealed to prevent disassembly. Do not attempt to remove spring from its pocket. Uncontrolled release of spring tension may occur causing property damage, personal injury, or death.

 **WARNING:** Carefully inspect all wire connections after any service work is conducted. Failure to do so could result in property damage, personal injury, or death.

MAINTENANCE

ELECTRICAL

1. Inspect all cable connections at least monthly.
2. Resistance through the reel slip ring assembly should never exceed 0.001 ohms. If so, return to Aero-Motive Company for inspection and repair.

NOTE: The slip ring assembly has been designed in such manner that it cannot be disassembled

REPLACEMENT PARTS

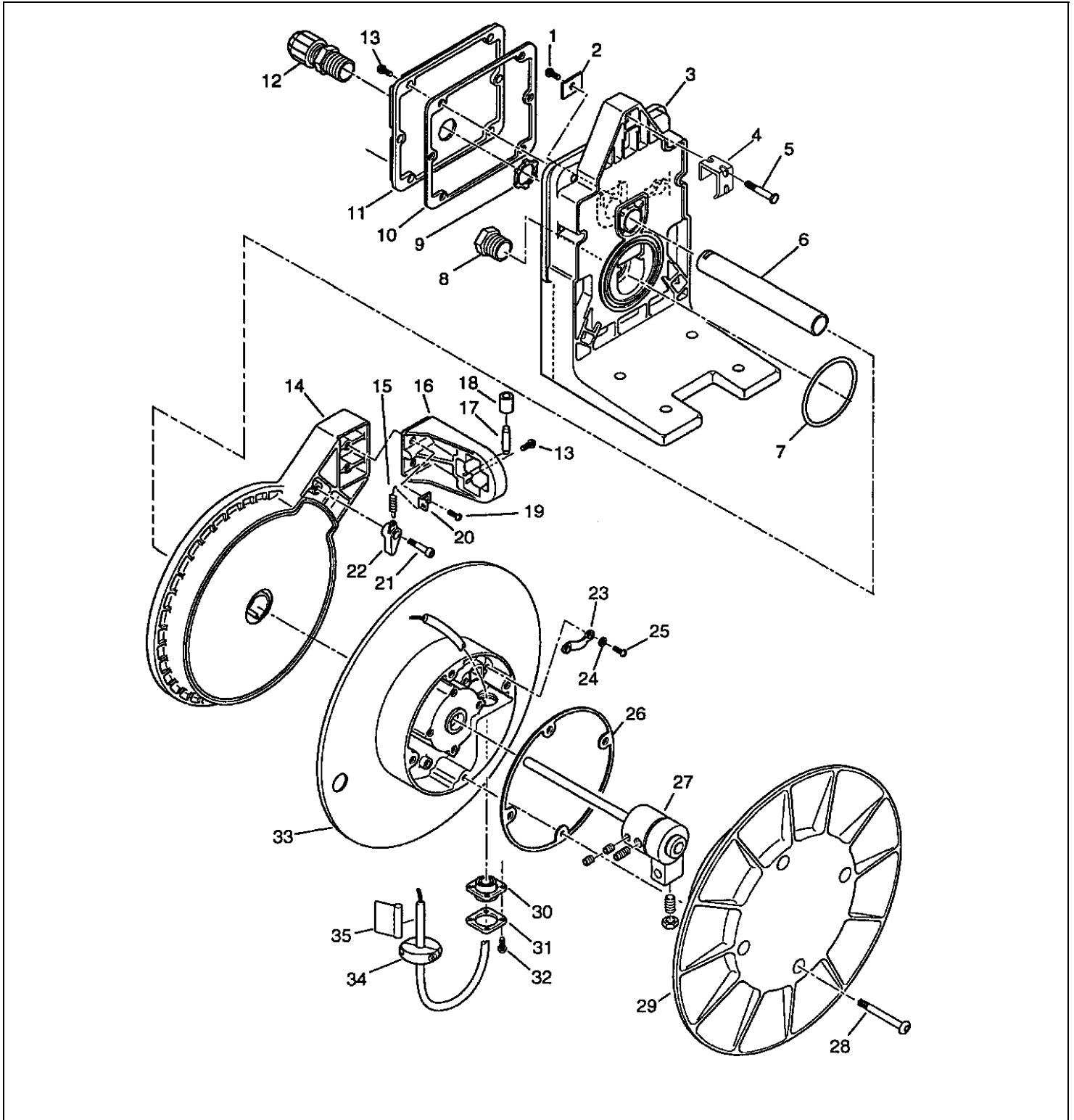

Reference Number *	Part Number	Qty.	Description
1	C03500231	1	SCREW; PAN HD. M5 X 12MM
2	M41100003	1	SHAFT RETAINER
3	H22110385	1	BASE
4		3	CLAMP-Included in clamp kit B below.
5		3	SCREW; HEX HD. M6 -Included in clamp kit B below.
6	M34370006	1	MAIN SHAFT, ELECTRICAL WELDING REEL
7	C47040141	1	O-RING
8	C34620105	1	THREAD PLUG
9	C71140112	1	NUT; 3/4" NPT LOCKING
10	M14240007	1	JUNCTION BOX GASKET
11	H82640002	1	JUNCTION BOX COVER
12	C75620419	1	STRAIN RELIEF CONNECTOR, 3/4" NPT .500
13	C03500253	10	SCREW; PAN HD. M6 X 16MM – Included in roller guide kit C below.
14	H41220076	1	SPRING POCKET ASSEMBLY
15	C60610121	1	EXTENSION SPRING
16	M04730007	1	CABLE GUIDE – Included in roller guide kit C below.
17	M24060125	4	ROLLER SHAFT – Included in roller guide kit C below.
18	M86700006	4	ROLLER – Included in roller guide kit C below.
19	C03500255	2	SCREW; PAN HD. M6 X 20MM
20	M53350002	1	SPRING CLIP
21	C15070225	1	SCREW; SHDR M8 X 10 X 16MM
22	M86750002	1	RATCHET PAWL
23	M70780007	1	CABLE CLAMP
24	C01070517	2	FLAT WASHER M5
25	C03500237	2	SCREW PAN HD M5
26		1	DRUM GASKET – Included in drum kit A below.
27	H96610001	1	SLIP RING ASS'Y, ELECTRIC WELDING REEL
28		4	SCREW – Included in drum kit A below.
29		1	OUTER DRUM HALF – Included in drum kit A below.
30	M86550002	1	CABLE SEAL
31	M37810027	1	SEAL COVER
32	C03500201	4	SCREW PAN HD. M4 X 12MM
33		1	INNER DRUM HALF – Included in drum kit A below.
34	STM2	1	CABLE STOP (ST2 KIT)
35		1	WARNING LABEL – Included in drum kit A below.
36		1	SLIP RING BRACKET – Included in drum kit A below.
37		2	SCREW; PAN HD. M8 X 16MM – Included in drum kit A below.
KIT A	H05040005	AR	DRUM KIT – (GR900) Includes items #'s 26, 28, 29, 33, 35, 36 & 37
KIT B	H05040013	AR	CLAMP KIT- STAINLESS STEEL- Includes 3 each of # 4 & 5.
KIT C	H26340009	AR	ROLLER GUIDE KIT – Includes item # 13, 16, 17, and 18.

Aero-Motive Company

W A Woodhead Industries Inc. Subsidiary
 PO Box 2678
 Kalamazoo, MI 49003-2678
 (616) 337 7700
 (800) 999 8559
 FAX: (800) 333 6119
 www.aeromotive.com

AKAPP Electro Industrie

W A Woodhead Industries Inc. Subsidiary
 Nijverheidsweg 14 Box 54
 NL-3771 ME Barneveld
 NL-3771 AB Barneveld
 Holland
 (31) 34 241 4022
 FAX: (31) 34 249 2384
 www.akapp.com

Woodhead Connectivity LTD.

W A Woodhead Industries Inc. Subsidiary
 Factory No. 9
 Rassau Industrial Estate
 Ebbw Vale Gwent NP3 5SD
 United Kingdom
 (0495) 35 0436
 FAX: (0495) 35 0877
 sales@wdhd.co.uk

Woodhead Asia PTE LTD.

W A Woodhead Industries Inc. Subsidiary
 401 Commonwealth Drive #04-04
 Haw Par Technocentre
 Singapore 0314
 (65) 261 6533
 FAX: (65) 479 3588
 sales@wasia.com.sg

Woodhead Canada LTD.

W A Woodhead Industries Inc. Subsidiary
 1090 Brevik Place
 Mississauga Ontario
 L4W 3Y5 Canada
 (905) 624-6518
 FAX: (905) 624-9151
 www.woodhead.ca